



Industrial Tube Fittings, Adapters and Equipment

Catalog 4300 December 2011

aerospace
climate control
electromechanical
filtration
fluid & gas handling
hydraulics
pneumatics
process control
sealing & shielding



ENGINEERING YOUR SUCCESS.





















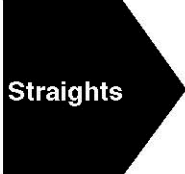



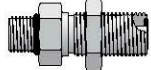

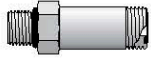



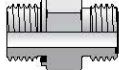



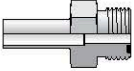
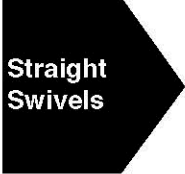
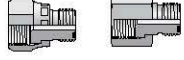

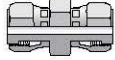
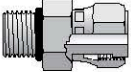
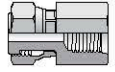
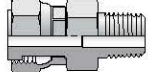
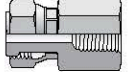

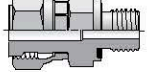
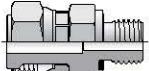

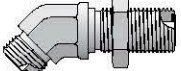
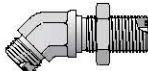
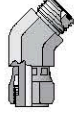









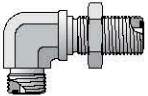
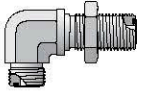
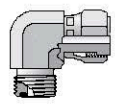
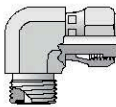
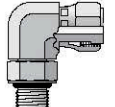
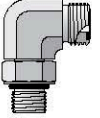
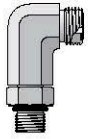

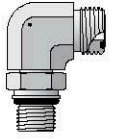
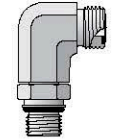
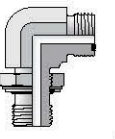
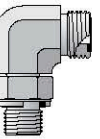
Seal-Lok™ O-Ring Face Seal Tube Fittings

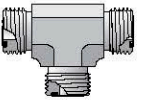
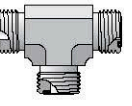
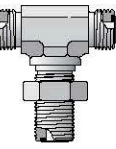
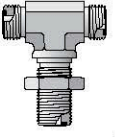
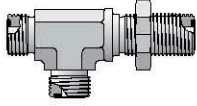
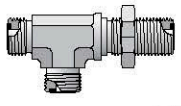
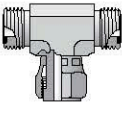
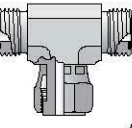
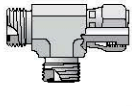
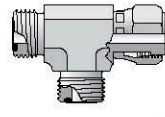
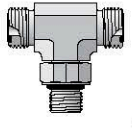
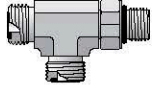
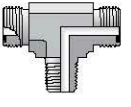
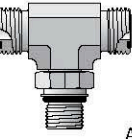
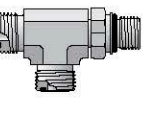
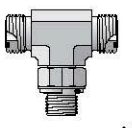
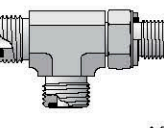
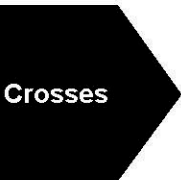
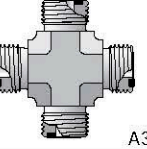
A



ENGINEERING YOUR SUCCESS.

	<p>BL Tube Nut</p>  <p>A9</p>	<p>BML Tube Nut - mm Hex</p>  <p>A9</p>	<p>TPLS (Metric) Parflange Sleeve</p>  <p>A9</p>	<p>TPL (Inch) Parflange Sleeve</p>  <p>A9</p>	<p>TL (Inch) Braze Reducer Sleeve</p>  <p>A10</p>
<p>TLS (Metric) Braze Reducer Sleeve</p>  <p>A10</p>	<p>SBR (Inch and Metric) Braze Ring</p>  <p>A11</p>	<p>WLNL Bulkhead Locknut</p>  <p>A11</p>	<p>WLNML Blkhd Locknut - mm Hex</p>  <p>A11</p>		<p>HLO Union</p>  <p>A12</p>
<p>HMLO Union - mm Hex</p>  <p>A12</p>	<p>WLO Bulkhead Union</p>  <p>A12</p>	<p>WMLO Bulkhead Union - mm Hex</p>  <p>A13</p>	<p>WF5OLO ORFS Blkhd / SAE-ORB</p>  <p>A13</p>	<p>F5OLO ORFS / SAE-ORB</p>  <p>A14</p>	<p>FF5OLO ORFS - Long / SAE-ORB</p>  <p>A14</p>
<p>FLO ORFS / NPTF</p>  <p>A14</p>	<p>GLO ORFS / NPTF</p>  <p>A15</p>	<p>F87OMLO ORFS / ISO 6149</p>  <p>A15</p>	<p>F82EDMLO ORFS / Metric-ED</p>  <p>A15</p>	<p>F42EDMLO ORFS / BSPP-ED</p>  <p>A15</p>	<p>LOHB3 ORFS / Braze Socket</p>  <p>A16</p>
<p>MMLOHB3 ORFS / Braze - mm Hex</p>  <p>A16</p>	<p>LOHT3 ORFS / Tube Weld</p>  <p>A16</p>		<p>TRLON Tube End Reducer</p>  <p>A17</p>	<p>LOHL6 Extender and Expander</p>  <p>A17</p>	<p>HL6 ORFS Swivel Union</p>  <p>A17</p>
<p>F65OL ORFS Swivel / SAE-ORB</p>  <p>A18</p>	<p>G65L ORFS Swivel / SAE-ORB</p>  <p>A18</p>	<p>F6L ORFS Swivel / NPTF</p>  <p>A18</p>	<p>G6L ORFS Swivel / NPTF</p>  <p>A18</p>	<p>F687OML ORFS Swivel / ISO 6149</p>  <p>A19</p>	<p>F682EDML ORFS Swivel / Metric-ED</p>  <p>A19</p>
<p>F642EDML ORFS Swivel / BSPP-ED</p>  <p>A19</p>		<p>WNLO Bulkhead Union</p>  <p>A19</p>	<p>WLNML Bulkhead Union - mm Hex</p>  <p>A20</p>	<p>V6LO ORFS Swivel Elbow</p>  <p>A20</p>	<p>V5OLO ORFS / SAE-ORB</p>  <p>A20</p>
<p>V87OMLO ORFS / ISO 6149</p>  <p>A20</p>	<p>VLO ORFS / NPTF</p>  <p>A21</p>	<p>V40MLO ORFS / BSPP-ORR</p>  <p>A21</p>		<p>ELO Union Elbow</p>  <p>A21</p>	<p>EMLO Union Elbow - mm Hex</p>  <p>A21</p>

<p>WELO Bulkhead Union</p>  <p>A22</p>	<p>WEMLO Bulkhead Union - mm Hex</p>  <p>A22</p>	<p>C6LO ORFS Swivel Elbow</p>  <p>A23</p>	<p>C6MLO Swivel Elbow - mm Hex</p>  <p>A23</p>	<p>AOEL6 ORFS Swivel / SAE-ORB</p>  <p>A23</p>	<p>C5OLO ORFS / SAE-ORB</p>  <p>A23</p>
<p>CC5OLO ORFS / SAE-ORB - Long</p>  <p>A24</p>	<p>CLO ORFS / NPTF</p>  <p>A24</p>	<p>C87OMLO ORFS / ISO 6149</p>  <p>A24</p>	<p>CC87OMLO ORFS / ISO 6149 - Long</p>  <p>A25</p>	<p>C8OMLO ORFS / Metric-ORR</p>  <p>A25</p>	<p>C4OMLO ORFS / BSPP-ORR</p>  <p>A26</p>
<p>Tees</p> 	<p>JLO Union Tee</p>  <p>A26</p>	<p>JMLO Union Tee - mm Hex</p>  <p>A26</p>	<p>WJLO Bulkhead Branch</p>  <p>A26</p>	<p>WJMLO Bikhd Branch - mm Hex</p>  <p>A27</p>	<p>WJJLO Bulkhead Run</p>  <p>A27</p>
<p>WJJMLO Bulkhead Run - mm Hex</p>  <p>A28</p>	<p>S6LO ORFS Swivel Branch</p>  <p>A28</p>	<p>S6MLO Swivel Branch - mm Hex</p>  <p>A28</p>	<p>R6LO ORFS Swivel Run</p>  <p>A29</p>	<p>R6MLO Swivel Run - mm Hex</p>  <p>A29</p>	<p>S5OLO SAE-ORB Branch Tee</p>  <p>A29</p>
<p>R5OLO SAE-ORB Run Tee</p>  <p>A30</p>	<p>SLO NPTF Branch Tee</p>  <p>A30</p>	<p>S87OMLO ISO 6149 Branch Tee</p>  <p>A30</p>	<p>R87OMLO ISO 6149 Run Tee</p>  <p>A31</p>	<p>S4OMLO BSPP-ORR Branch Tee</p>  <p>A31</p>	<p>R4OMLO BSPP-ORR Run Tee</p>  <p>A32</p>
<p>Crosses</p> 	<p>KLO Union Cross</p>  <p>A32</p>	<p>Plugs, Caps and Bleed Adapters</p> 	<p>PNLO ORFS Plug</p>  <p>A33</p>	<p>PNMLO ORFS Plug - mm Hex</p>  <p>A33</p>	<p>FNL ORFS Cap</p>  <p>A33</p>
<p>FNML ORFS Cap - mm Hex</p>  <p>A33</p>	<p>UPTC Nut Assembly</p> 	<p>UPTC Nut Assembly</p>  <p>A34</p>			

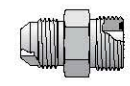
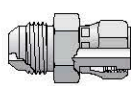
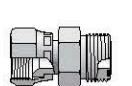
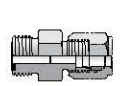
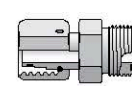
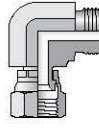

Conversion Adapters (Shown in Section K)

 <p>Conversion Adapters</p>	<p>XHLO 37° Flare / ORFS</p>  <p>K3</p>	<p>XHL6 37° Flare / ORFS Swivel</p>  <p>K3</p>	<p>LOHX6 ORFS / 37° Swivel</p>  <p>K3</p>	<p>BUHLO ORFS / Flareless (inch)</p>  <p>K4</p>	<p>LOHU86 Metric Swivel (EO)/ORFS</p>  <p>K4</p>
	<p>LOEX6 ORFS / 37° Swivel</p>  <p>K3</p>				

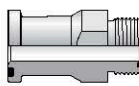
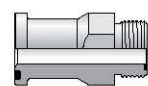
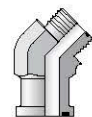
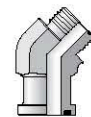
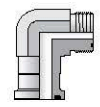
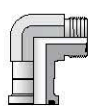

Flange Adapters (Shown in Section L)

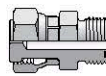
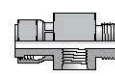
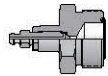
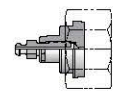
 <p>SAE Flange Adapters</p>	<p>LOHQ1 Code 61 / ORFS</p>  <p>L12</p>	<p>LOHQ2 Code 62 / ORFS</p>  <p>L12</p>	<p>LOVQ1 Code 61 / ORFS</p>  <p>L30</p>	<p>LOVQ2 Code 62 / ORFS</p>  <p>L30</p>	<p>LOEQ1 Code 61 / ORFS</p>  <p>L31</p>
	<p>LOEQ2 Code 62 / ORFS</p>  <p>L31</p>				

Diagnostic, Bleed Adapters & Screen Fittings (Shown in Section M)

 <p>Diagnostic, Bleed Adapters & Screen Fittings</p>	<p>LOHL6 Orifice Orifice Swivel with Orifice / ORFS</p>  <p>M9</p>	<p>LOHL6G5TP Orifice Swivel / ORFS / SAE-ORB</p>  <p>M5</p>	<p>PNLOBA Bleed Screw / ORFS</p>  <p>M10</p>	<p>FNLBA Bleed Screw / SAE-ORB</p>  <p>M10</p>	<p>Screen Fittings</p>  <p>M12</p>

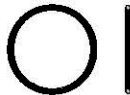
O-Rings and Seals (Shown in Section N)

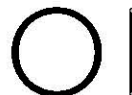
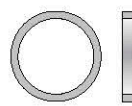
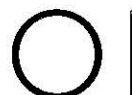
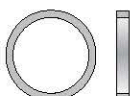
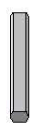
 <p>O-Rings and Seals</p>	<p>ORFS O-Ring</p>  <p>N4</p>	<p>SAE O-Ring</p>  <p>N4</p>	<p>ISO 6149 O-Ring</p>  <p>N5</p>	<p>Metric O-Ring</p>  <p>N5</p>	<p>Metric Retaining Ring</p>  <p>N5</p>
	<p>BSPP O-Ring</p>  <p>N6</p>	<p>BSPP Retaining O-Ring</p>  <p>N6</p>	<p>Elastic Seal Ring</p>  <p>N6</p>		















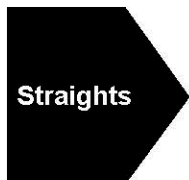
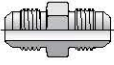
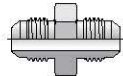
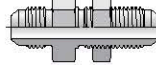
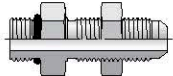
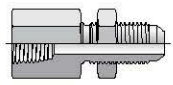
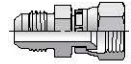
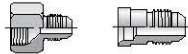
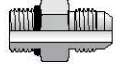
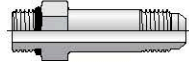
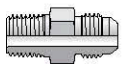

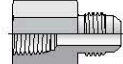

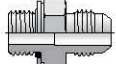
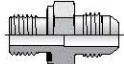
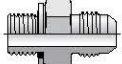
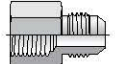
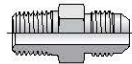
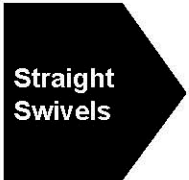
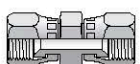
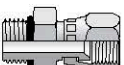



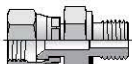





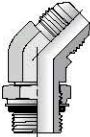
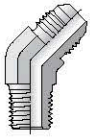

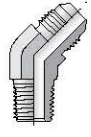

Triple-Lok™ & Triple-Lok™ 2 37° Flare Tube Fittings

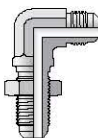
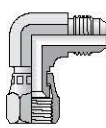
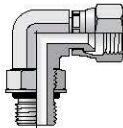
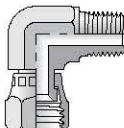
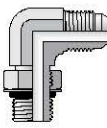
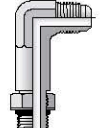
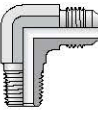
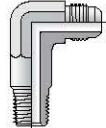
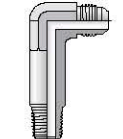
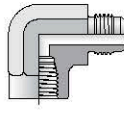
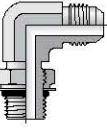
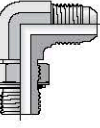
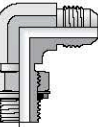
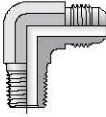
B

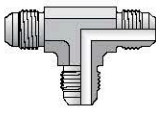
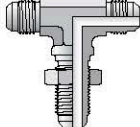
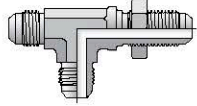
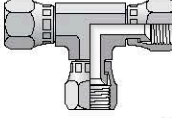
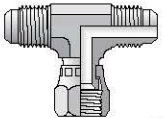
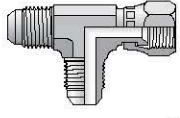
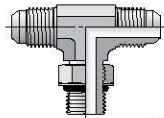
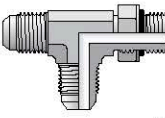
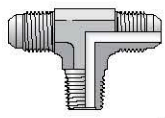
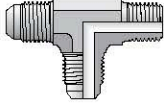
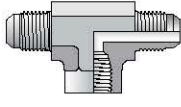
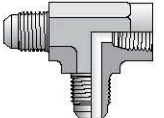
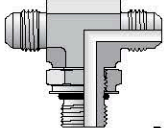
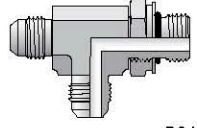
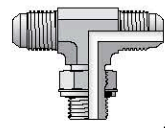
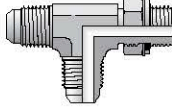
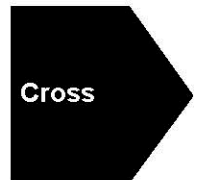





ENGINEERING YOUR SUCCESS.

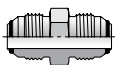

	BTX Nut  B9	TX and TX Metric Sleeve  B9	WLN Bulkhead Locknut  B10	SBR Braze Ring  B10	
		HTX Union  B10	LHTX Large Hex Union  B10	WTX Bulkhead Union  B11	WF5OX SAE-ORB / 37° Bulkhead  B11
WGTX NPTF / 37° Bulkhead  B12		XXH6 Extender and Expander  B12	TRTX / TRTXN Reducer  B13	F5OX SAE-ORB / 37° Flare  B14	FF5OX SAE-ORB / 37° – Long  B14
FTX NPTF / 37° Flare  B15	FFTX NPTF / 37° Flare – Long  B15	GTX NPTF / 37° Flare  B15	F87OMX ISO 6149 / 37° Flare  B16	F82EDMX Metric-ED / 37° Flare  B16	F8OMX Metric-ORR / 37° Flare  B16
F42EDMX BSPP-ED / 37° Flare  B16	F4OMX BSPP-ORR / 37° Flare  B17	G4MX BSPP / 37° Flare  B17	F3MX BSPT / 37° Flare  B17		HX6 37° Swivel Union  B17
F65OX SAE-ORB / 37° Swivel  B18	F6X NPTF / 37° Swivel  B18	G6X NPTF / 37° Swivel  B18	F687OMX ISO-6149 / 37° Swivel  B18		F68OMX Metric-ORR / 37° Swivel  B19
F642EDMX BSPP-ED / 37° Swivel  B19	F63MX BSPT / 37° Swivel  B19		WNTX Bulkhead Union  B20	V6X 37° Swivel Elbow  B20	V5OX SAE-ORB / 37° Flare  B20
V87OMX ISO-6149 / 37° Flare  B20	VTX NPTF / 37° Flare  B21		V4OMX BSPP-ORR / 37° Flare  B21	V3MX BSPT / 37° Flare  B21	

<p>WETX Bulkhead Union</p>  <p>B22</p>	<p>C6X 37° Swivel Elbow</p>  <p>B22</p>	<p>AOEX6 SAE-ORB / 37° Swivel</p>  <p>B22</p>	<p>X6EF NPTF / 37° Swivel</p>  <p>B23</p>	<p>C5OX SAE-ORB / 37° Flare</p>  <p>B23</p>	<p>CC5OX SAE-ORB / 37° – Long</p>  <p>B23</p>
<p>CTX NPTF / 37° Flare</p>  <p>B24</p>	<p>CCTX NPTF / 37° Flare – Long</p>  <p>B24</p>	<p>CCCTX NPTF / 37° – Extra Long</p>  <p>B24</p>	<p>DTX NPTF / 37° Flare</p>  <p>B25</p>	<p>C87OMX ISO-6149 / 37° Flare</p>  <p>B25</p>	<p>C8OMX Metric-ORR / 37° Flare</p>  <p>B25</p>
<p>C4OMX BSPP-ORR / 37° Flare</p>  <p>B26</p>	<p>C3MX BSPT / 37° Flare</p>  <p>B26</p>	<p>Tees</p> 	<p>JTX Union Tee</p>  <p>B26</p>	<p>WJTX Bulkhead Branch Tee</p>  <p>B27</p>	<p>WJJTX Bulkhead Run Tee</p>  <p>B27</p>
<p>JX6 37° Swivel Union Tee</p>  <p>B28</p>	<p>S6X 37° Swivel Branch Tee</p>  <p>B28</p>	<p>R6X 37° Swivel Run Tee</p>  <p>B28</p>	<p>S5OX SAE-ORB Branch Tee</p>  <p>B29</p>	<p>R5OX SAE-ORB Run Tee</p>  <p>B29</p>	<p>STX NPTF Branch Tee</p>  <p>B30</p>
<p>RTX NPTF Run Tee</p>  <p>B30</p>	<p>OTX NPTF Branch Tee</p>  <p>B30</p>	<p>MTX NPTF Run Tee</p>  <p>B30</p>	<p>S87OMX ISO 6149 Branch Tee</p>  <p>B31</p>	<p>R87OMX ISO 6149 Run Tee</p>  <p>B31</p>	<p>S4OMX BSPP-ORR Branch Tee</p>  <p>B31</p>
<p>R4OMX BSPP-ORR Run Tee</p>  <p>B31</p>	<p>Cross</p> 	<p>KTX Union Cross</p>  <p>B32</p>	<p>Plug and Cap</p> 	<p>PNTX 37° Plug</p>  <p>B32</p>	<p>FNTX 37° Cap</p>  <p>B32</p>
<p>T22X Mountie Cap</p>  <p>B32</p>					

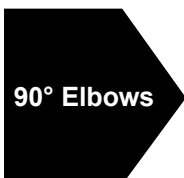
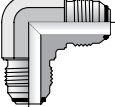
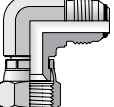
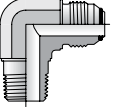
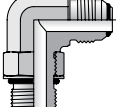
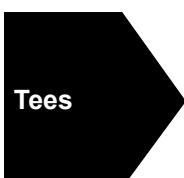
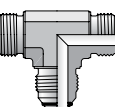
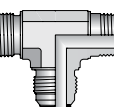
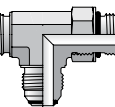

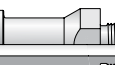
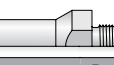

Triple-Lok® 2 Soft Seal Flare Tube Fittings

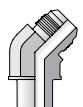
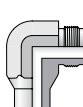
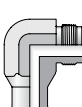
 <p>Straights</p>	<p>HTXO Union</p>  <p>B33</p>	<p>F5OXO SAE-ORB / 37° Flare</p>  <p>B33</p>	<p>FTXO NPTF / 37° Flare</p>  <p>B33</p>	<p>GTXO NPTF / 37° Flare</p>  <p>B33</p>
 <p>90° Elbows</p>	<p>ETXO Union Elbow</p>  <p>B34</p>	<p>C6XO 37° Swivel Elbow</p>  <p>B34</p>	<p>CTXO NPTF / 37° Flare</p>  <p>B34</p>	<p>C5OXO SAE-ORB / 37° Flare</p>  <p>B34</p>
 <p>Tees</p>	<p>JTXO Union Tee</p>  <p>B35</p>	<p>RTXO 37° Swivel Run Tee</p>  <p>B35</p>	<p>R5OXO SAE-ORB Run Tee</p>  <p>B35</p>	

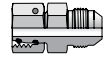
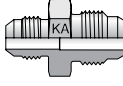
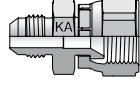
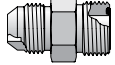
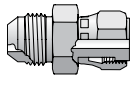

Flange Adapters (Shown in Section L)

 <p>SAE Flange Adapters</p>	<p>XHQ1 Code 61 / 37° Flare</p>  <p>L12</p>	<p>XHQ2 Code 62 / 37° Flare</p>  <p>L12</p>	<p>XVQ1 Code 61 / 37° Flare</p>  <p>L30</p>	<p>XVQ2 Code 62 / 37° Flare</p>  <p>L30</p>	<p>XEQ1 Code 61 / 37° Flare</p>  <p>L31</p>
<p>XEQ2 Code 62 / 37° Flare</p>  <p>L31</p>					

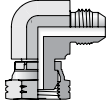

Conversion Adapters (Shown in Sections J and K)

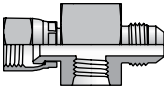
	XHU86 Metric Swivel (EO) / 37°  K5	XHMKA Komatsu 30° / 37° Flare  J5	XHMKA6 Komatsu 30° Swivel / 37°  J5	XHLO 37° Flare / ORFS  K3	XHL6 37° Flare / ORFS Swivel  K3
	LOHX6 ORFS / 37° Swivel  K3	XHBU 37° Flare / Flareless  K4	XHMK46 37° Flare / BSPP Swivel  K5	XEMK46 37° Flare / BSPP Swivel  K5	

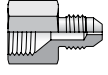
Diagnostic and Orifice Fittings (Shown in Section M)

	XHX6G5TP 37° Flare / 37° Swivel / SAE-ORB  M5		XHX7 37° Flare / 37° Female with Orifice  M9

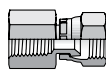

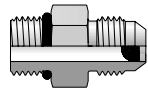

Gauge Fittings (Shown in Section M)

	G6X NPT Gauge / 37° Swivel  M7	G4MXSMO BSPP Gauge / 37° Flare  M6

Screen Fittings (Shown in Section M)

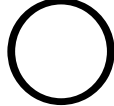
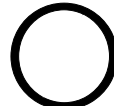
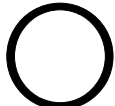
	Screen Fittings  M12

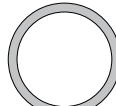
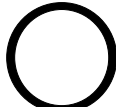
O-Rings and Seals (Shown in Section N)

	XO O-Ring  N4	SAE O-Ring  N4	ISO 6149 O-Ring  N5	Metric O-Ring  N5	Metric Retaining Ring  N5
	BSPP O-Ring  N6	BSPP Retaining Ring  N6	EoElastic Seal Ring  N6		













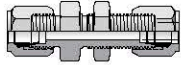
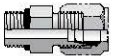
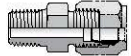

Ferulok[®] Flareless Bite Type Fittings

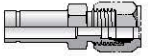
C

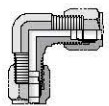
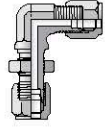
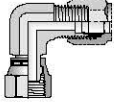

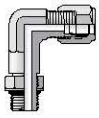
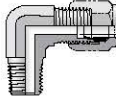
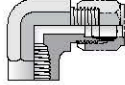
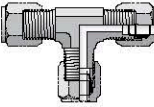
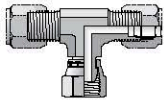
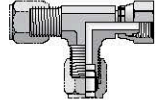
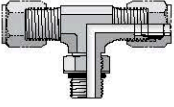
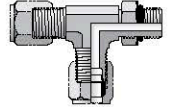
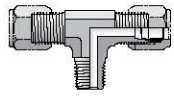
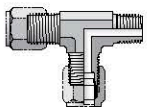
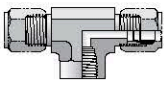
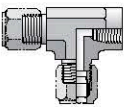
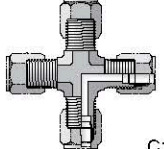
ENGINEERING YOUR SUCCESS.



<p>Nuts, Ferrules, Locknuts</p>	<p>BU Nut</p>  <p>C7</p>	<p>TU Ferrules</p>  <p>C7</p>	<p>WLN Bulkhead Locknut</p>  <p>C7</p>	<p>Straights</p>	<p>HBU Union</p>  <p>C7</p>
<p>WBU Bulkhead Union</p>  <p>C8</p>	<p>F5BU SAE-ORB / Flareless</p>  <p>C8</p>	<p>FBU NPTF / Flareless</p>  <p>C8</p>	<p>GBU NPTF / Flareless</p>  <p>C9</p>	<p>TRBU Tube End Reducer</p>  <p>C9</p>	
<p>45° Elbows</p>	<p>V5BU SAE-ORB / Flareless</p>  <p>C9</p>	<p>VBU NPTF / Flareless</p>  <p>C9</p>	<p>90° Elbows</p>	<p>EBU Union Elbow</p>  <p>C10</p>	<p>WEBU Bulkhead Union Elbow</p>  <p>C10</p>
<p>C6BU Flareless Swivel/Flareless</p>  <p>C10</p>	<p>C5BU SAE-ORB / Flareless</p>  <p>C10</p>	<p>CC5BU SAE-ORB / Flareless</p>  <p>C11</p>	<p>CBU NPTF / Flareless</p>  <p>C11</p>	<p>DBU NPTF / Flareless</p>  <p>C11</p>	
<p>Tees</p>	<p>JBU Union Tee</p>  <p>C12</p>	<p>S6BU Swivel Branch Tee</p>  <p>C12</p>	<p>R6BU Swivel Run Tee</p>  <p>C12</p>	<p>S5BU SAE-ORB Branch Tee</p>  <p>C12</p>	<p>R5BU SAE-ORB Run Tee</p>  <p>C13</p>
<p>SBU NPTF Branch Tee</p>  <p>C13</p>	<p>RBU NPTF Run Tee</p>  <p>C13</p>	<p>OBU NPTF Branch Tee</p>  <p>C13</p>	<p>MBU NPTF Run Tee</p>  <p>C14</p>	<p>Cross</p>	<p>KBU Union Cross</p>  <p>C14</p>
<p>Plugs and Caps</p>	<p>PNU Plug</p>  <p>C14</p>	<p>FNU Cap</p>  <p>C14</p>			

Dimensions and pressures for reference only, subject to change.

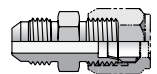
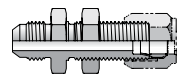
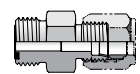
Conversion Adapters (Shown in Section K)

	<p>XHBU 37° Flare / Flareless</p> 	<p>XHBU2 37° / Flareless Bulkhead</p> 	<p>BUHLO ORFS / 24° Flareless</p> 
	K4	K4	K4

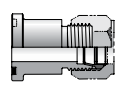
Flange Adapters (Shown in Section L)

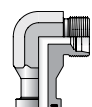
	<p>BUHQ1 Code 61 / Flareless</p> 	<p>BUVQ1 Code 61 / Flareless</p> 	<p>BUEQ1 Code 61 / Flareless</p> 
	L12	L30	L31

O-Rings and Seals (Shown in Section N)

	<p>SAE O-Ring</p> 
	N4

Dimensions and pressures for reference only, subject to change.



















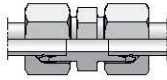
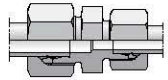
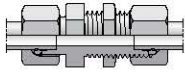

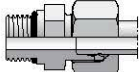
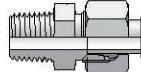
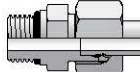
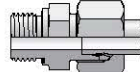

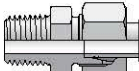

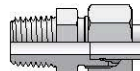
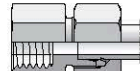
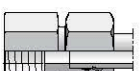
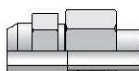

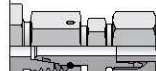

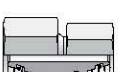
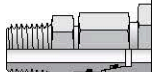

E0 and E0-2 Metric Bite Type Fittings

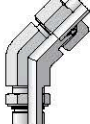

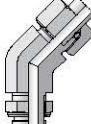
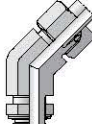
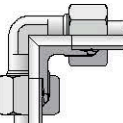
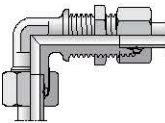
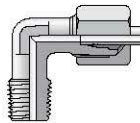
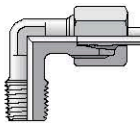
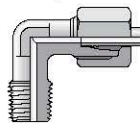

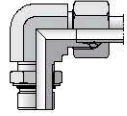
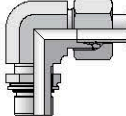
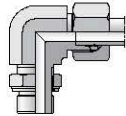
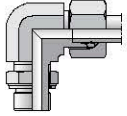
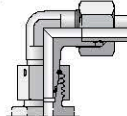
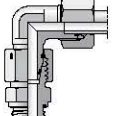
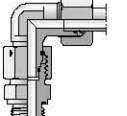
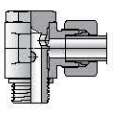
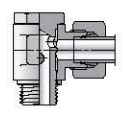
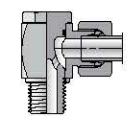
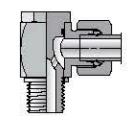
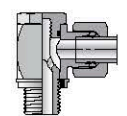
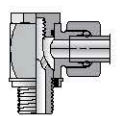
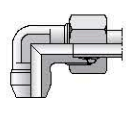
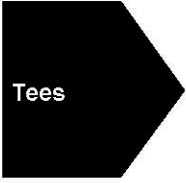
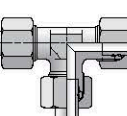
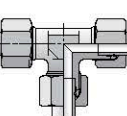
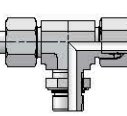
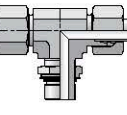
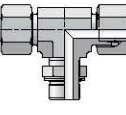
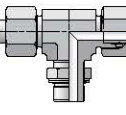
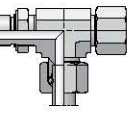
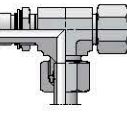
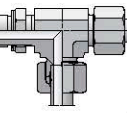
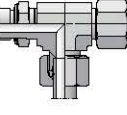
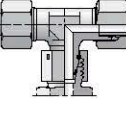
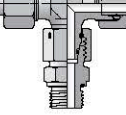
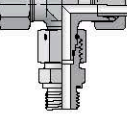
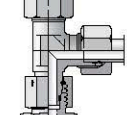
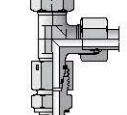
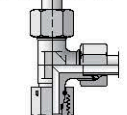
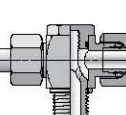
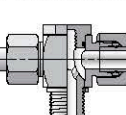
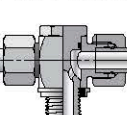
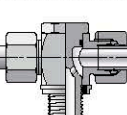
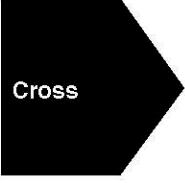
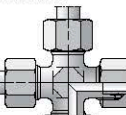

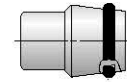
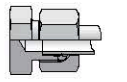

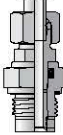
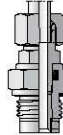
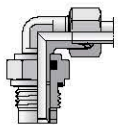
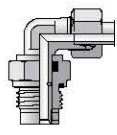



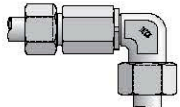
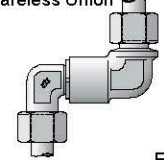

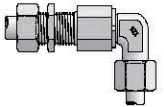
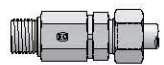
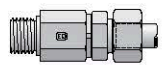
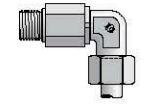
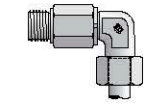
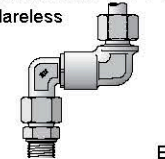
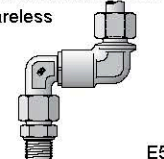
E

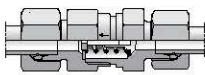
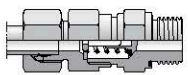
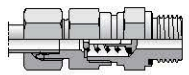
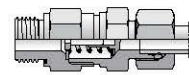
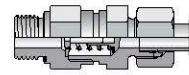
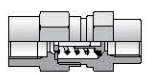

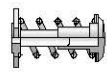
ENGINEERING YOUR SUCCESS.

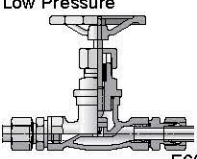
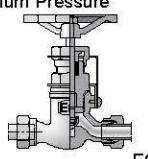
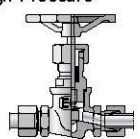
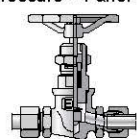
<p>Nuts, Sleeves, Locknut, Inserts</p>	<p>M Nut</p>  <p>E13</p>	<p>FM Functional Nut</p>  <p>E14</p>	<p>DPR Progressive Ring</p>  <p>E13</p>	<p>D Cutting Ring</p>  <p>E13</p>	<p>PSR Progressive Ring</p>  <p>E13</p>
<p>GM Bulkhead Locknut</p>  <p>E15</p>	<p>E Insert for Plastic Tube</p>  <p>E15</p>	<p>VH Insert for Metal Tube</p>  <p>E15</p>	<p>Straights</p>	<p>G Union</p>  <p>E16</p>	<p>GR Reducer Union</p>  <p>E16</p>
<p>SV Bulkhead Union</p>  <p>E17</p>	<p>ESV Weld Bulkhead Union</p>  <p>E17</p>	<p>GE-UNF/UN SAE-ORB / Flareless</p>  <p>E18</p>	<p>GE-NPT NPT / Flareless</p>  <p>E18</p>	<p>GEO ISO 6149 / Flareless</p>  <p>E19</p>	<p>GE-R-ED BSPP-ED / Flareless</p>  <p>E19</p>
<p>GE-R BSPP / Flareless</p>  <p>E20</p>	<p>GE-R keg BSPT / Flareless</p>  <p>E20</p>	<p>GE-M-ED Metric-ED / Flareless</p>  <p>E21</p>	<p>GE-M Metric / Flareless</p>  <p>E22</p>	<p>GE-M keg Metric Taper / Flareless</p>  <p>E22</p>	<p>GAI-R Female BSPP / Flareless</p>  <p>E22</p>
<p>GAI-M Female Metric / Flareless</p>  <p>E23</p>	<p>AS Butt Weld / Flareless</p>  <p>E23</p>	<p>Straight Swivels</p>	<p>RED Tube End Reducer</p>  <p>E24</p>	<p>DA Extender</p>  <p>E25</p>	<p>GZ Swivel Union</p>  <p>E25</p>
<p>GZR Swivel Union Reducer</p>  <p>E25</p>	<p>EGE-NPT NPT / Flareless Swivel</p>  <p>E25</p>	<p>EGEO ISO 6149 / Flareless Swivel</p>  <p>E26</p>	<p>EGE-R-ED BSPP-ED / Flareless Swivel</p>  <p>E26</p>	<p>EGE-M-ED Metric-ED / Flareless Swivel</p>  <p>E26</p>	<p>SKA Butt Weld / Flareless Swivel</p>  <p>E26</p>
<p>45° Elbows</p>	<p>VEE-UNF/UN SAE-ORB / Flareless</p>  <p>E27</p>	<p>VEE-OR ISO 6149 / Flareless</p>  <p>E27</p>	<p>VEE-R BSPP-ORR / Flareless</p>  <p>E28</p>	<p>VEE-M Metric-ORR / Flareless</p>  <p>E28</p>	
<p>90° Elbows</p>	<p>W Union Elbow</p>  <p>E29</p>	<p>WSV Bulkhead Union Elbow</p>  <p>E30</p>	<p>WE-NPT NPT / Flareless</p>  <p>E30</p>	<p>WE-R keg BSPT / Flareless</p>  <p>E31</p>	<p>WE-M keg Metric Taper / Flareless</p>  <p>E31</p>

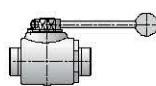
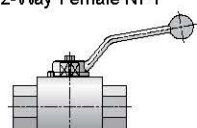
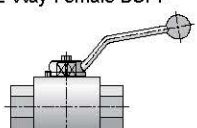

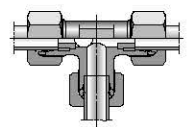
<p>WEE-UNF/UN SAE-ORB / Flareless</p>  <p>E32</p>	<p>WEE-OR ISO 6149 / Flareless</p>  <p>E32</p>	<p>WEE-R BSPP-ORR / Flareless</p>  <p>E33</p>	<p>WEE-M Metric-ORR / Flareless</p>  <p>E33</p>	<p>EW Flareless Swivel / Flareless</p>  <p>E34</p>	<p>EW-R-ED BSPP-ED / Flareless</p>  <p>E35</p>	
<p>EW-M-ED Metric-ED / Flareless</p>  <p>E35</p>	<p>SWVE-R Banjo BSPP / Flareless</p>  <p>E36</p>	<p>SWVE-M Banjo Metric / Flareless</p>  <p>E36</p>	<p>WH-R Banjo BSPP / Flareless</p>  <p>E37</p>	<p>WH-M Banjo Metric / Flareless</p>  <p>E37</p>	<p>WH-R-KDS Banjo BSPP / Flareless</p>  <p>E38</p>	
<p>WH-M-KDS Banjo Metric / Flareless</p>  <p>E38</p>	<p>WAS Butt Weld / Flareless</p>  <p>E39</p>	<p>Tees</p> 		<p>T Union Tee</p>  <p>E39</p>	<p>TR Reducer Tee</p>  <p>E40</p>	<p>TEE-UNF/UN SAE-ORB Branch Tee</p>  <p>E41</p>
<p>TEE-OR ISO 6149 Branch Tee</p>  <p>E42</p>	<p>TEE-R BSPP-ORR Branch Tee</p>  <p>E42</p>	<p>TEE-M Metric-ORR Branch Tee</p>  <p>E43</p>	<p>LEE-UNF/UN SAE-ORB Run Tee</p>  <p>E43</p>	<p>LEE-OR ISO 6164 Run Tee</p>  <p>E44</p>	<p>LEE-R BSPP-ORR Run Tee</p>  <p>E44</p>	
<p>LEE-M Metric-ORR Run Tee</p>  <p>E44</p>	<p>ET Swivel Branch Tee</p>  <p>E45</p>	<p>ET-R-ED BSPP-ED Branch Tee</p>  <p>E45</p>	<p>ET-M-ED Metric-ED Branch Tee</p>  <p>E46</p>	<p>EL Swivel Run Tee</p>  <p>E46</p>	<p>EL-R-ED BSPP-ED Run Tee</p>  <p>E47</p>	
<p>EL-M-ED Metric-ED Run Tee</p>  <p>E47</p>	<p>TH-R Banjo BSPP Branch Tee</p>  <p>E48</p>	<p>TH-M Banjo Metric Branch Tee</p>  <p>E48</p>	<p>TH-R-KDS Banjo BSPP Branch Tee</p>  <p>E49</p>	<p>TH-M-KDS Banjo Metric Branch Tee</p>  <p>E49</p>		
<p>Cross</p> 		<p>K Union Cross</p>  <p>E50</p>	<p>Caps and Plugs</p> 		<p>VKA Flareless Cap</p>  <p>E50</p>	<p>ROV Flareless Plug</p>  <p>E50</p>
<p>Plain Bearing Rotary Fittings</p> 		<p>DVGE-R BSPP-ED / Flareless</p>  <p>E51</p>	<p>DVGE-M Metric-ED / Flareless</p>  <p>E52</p>	<p>DVWE-R BSPP-ED / Flareless</p>  <p>E51</p>	<p>DVWE-M Metric-ED / Flareless</p>  <p>E52</p>	

 <p>Ball Bearing Rotary Fittings</p>	<p>DG101 Flareless Union</p>  <p>E53</p>	<p>DG103 Flareless Union</p>  <p>E53</p>	<p>DG105 Flareless Union</p>  <p>E53</p>	<p>DG107 Union Bulkhead</p>  <p>E53</p>	<p>DG108 90° Union Bulkhead</p>  <p>E54</p>
<p>DG102-R BSPP-ED / Flareless</p>  <p>E54</p>	<p>DG102-M Metric-ED / Flareless</p>  <p>E54</p>	<p>DG104-R 90° BSPP-ED / Flareless</p>  <p>E54</p>	<p>DG104-M 90° Metric-ED / Flareless</p>  <p>E55</p>	<p>DG106-R Double Elbow BSPP / Flareless</p>  <p>E55</p>	<p>DG106-M Double Elbow Metric / Flareless</p>  <p>E55</p>
 <p>Check Valves</p>	<p>RHD Union</p>  <p>E56</p>	<p>RHV-R-ED BSPP-ED / Flareless</p>  <p>E56</p>	<p>RHV-M-ED Metric-ED / Flareless</p>  <p>E57</p>	<p>RHZ-R-ED BSPP-ED / Flareless</p>  <p>E57</p>	<p>RHZ-M-ED Metric-ED / Flareless</p>  <p>E58</p>
<p>RHDI Female BSPP Union</p>  <p>E58</p>	<p>RVP Cartridge</p>  <p>E59</p>	<p>I-TL Internal Parts</p>  <p>E59</p>	 <p>Shut-Off Valves</p>	<p>DV Low Pressure</p>  <p>E60</p>	<p>LD Medium Pressure</p>  <p>E60</p>
<p>VDHA High Pressure</p>  <p>E61</p>	<p>VDHB High Pressure – Panel Mount</p>  <p>E61</p>	 <p>Ball Valves</p>	<p>KH 2-Way Flareless Union</p>  <p>E62</p>	<p>KH-NPT 2-Way Female NPT</p>  <p>E64</p>	<p>KH-R 2-Way Female BSPP</p>  <p>E64</p>
 <p>Alternating Valves</p>	<p>WV Union Tee</p>  <p>E65</p>				

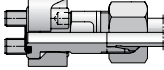
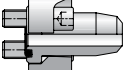
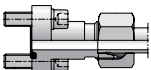
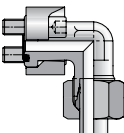
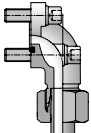



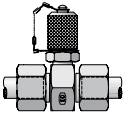
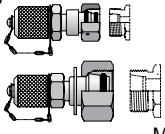

Flange Adapters (Shown in Section L)

	GFS Code 61, 62 / Metric Flareless  L14	AS Code 61, 62 / Weld Butt – Tube Metric  L26	BFG DIN Flange / Metric Flareless  L15	WFS Code 61, 62 / Metric Flareless  L33	BFW DIN Flange / Metric Flareless  L34
---	--	--	--	--	---

Diagnostic and Specialty Adapters (Shown in Section M)

	GMA3 EO Tube / EO Tube / EMA-3 Diagnostic Tip  M5	VKA3 EO Swivel / Diagnostic Tip  M8	MAVE BSPP Gauge / EO Swivel  M6	MAV BSPP Gauge / EO Tube  M6
---	--	--	--	---



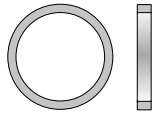







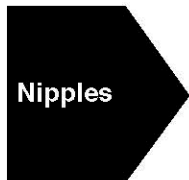
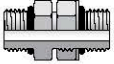
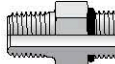
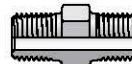
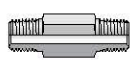
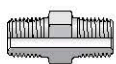





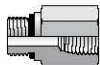





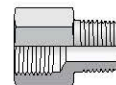
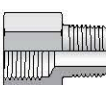
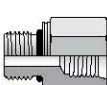
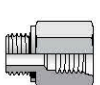



O-Rings and Seals (Shown in Section N)



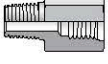
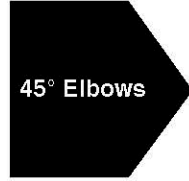

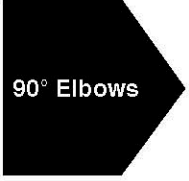

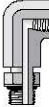

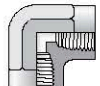
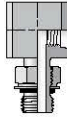
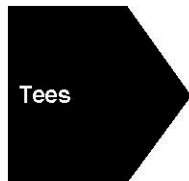
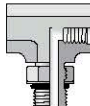
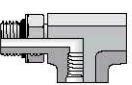
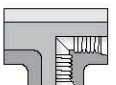
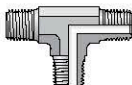
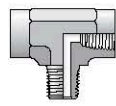

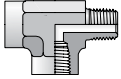

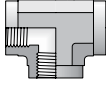
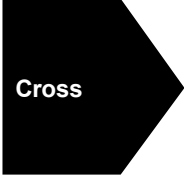



	KDS Bonded Seal for Banjo Fittings  N8	DKA Metal Seal for Banjo Fittings  N8	DKI Pressure Gauge Sealing Ring  N9	EO EOlastic Seal Ring  N6	OR EO O-Ring  N10
	DOZ EO-2 Sealing Ring  N7	RR Metric Retaining Ring  N5			





Pipe Fittings and Port Adapters

F

 <p>Nipples</p>	<p>F5OHAO SAE-ORB / SAE-ORB</p>  <p>F11</p>	<p>F5OF SAE-ORB / NPTF</p>  <p>F11</p>	<p>FF NPTF / NPTF</p>  <p>F11</p>	<p>FFF NPTF / NPTF Long</p>  <p>F11</p>	<p>FF33M BSPT / BSPT</p>  <p>F12</p>	
	<p>G5HG5 SAE-ORB / SAE-ORB</p>  <p>F12</p>	<p>GG NPTF / NPTF</p>  <p>F12</p>	<p>GG44M BSPP / BSPP</p>  <p>F12</p>	 <p>Reducers, Expanders, Conversions</p>		<p>F5OG5 SAE-ORB / SAE-ORB</p>  <p>F13</p>
<p>F5OG SAE-ORB / NPTF</p>  <p>F13</p>	<p>F5OHG8 SAE-ORB / Metric</p>  <p>F13</p>	<p>F5OHG4 SAE-ORB / BSPP</p>  <p>F13</p>	<p>FHG5 NPTF / SAE-ORB</p>  <p>F14</p>	<p>FG NPTF / NPTF</p>  <p>F14</p>	<p>PTR Pipe Thread Reducer</p>  <p>F14</p>	
<p>FHG8 NPTF / Metric</p>  <p>F14</p>	<p>FHG4 NPTF / BSPP</p>  <p>F15</p>	<p>F87OHG87M ISO 6149 / ISO 6149</p>  <p>F15</p>	<p>F8OHG5 Metric-ORR / SAE-ORB</p>  <p>F15</p>	<p>F8OHG Metric-ORR / NPTF</p>  <p>F15</p>	<p>F4OHG5 BSPP-ORR / SAE-ORB</p>  <p>F16</p>	
<p>F4OHG BSPP-ORR / NPTF</p>  <p>F16</p>	<p>PTR34M BSPT / BSPP</p>  <p>F16</p>	<p>RI-ED BSPP-ED / BSPP</p>  <p>F17</p>	<p>RI BSPP-CF / BSPP</p>  <p>F18</p>	<p>F3HG BSPT / NPTF</p>  <p>F19</p>	<p>F3HG5 BSPT / SAE-ORB</p>  <p>F19</p>	
 <p>45° Elbows</p>	<p>CD45 NPTF / NPTF</p>  <p>F19</p>	<p>DD45 NPTF / NPTF</p>  <p>F19</p>	 <p>90° Elbows</p>		<p>AOEG5 SAE-ORB / SAE-ORB</p>  <p>F19</p>	<p>AOEG SAE-ORB / NPTF</p>  <p>F19</p>
	<p>AOE4G SAE-ORB / NPTF Long</p>  <p>F20</p>	<p>CR NPTF / NPTF</p>  <p>F20</p>	<p>CD NPTF / NPTF</p>  <p>F20</p>	<p>DD NPTF / NPTF</p>  <p>F20</p>	<p>A87LPOEG87LPM ISO 6149 / ISO 6149</p>  <p>F21</p>	
 <p>Tees</p>	<p>G5G5JAO SAE-ORB Branch Tee</p>  <p>F21</p>	<p>AOG5JG5 SAE-ORB Run Tee</p>  <p>F22</p>	<p>G5G5JG5 SAE-ORB Tee</p>  <p>F22</p>	<p>RRS NPTF Tee</p>  <p>F22</p>	<p>MMS NPTF Branch Tee</p>  <p>F22</p>	

<p>MRO NPTF Run Tee</p>  <p>F22</p>	<p>MMO NPTF Tee</p>  <p>F23</p>	<p>MMO444M BSPP Tee</p>  <p>F23</p>	<p>Cross</p> 	<p>KMMOO NPTF Cross</p>  <p>F23</p>	
<p>Plugs, Bleed Adapters</p> 	<p>P50N SAE-ORB Hex Head</p>  <p>F23</p>	<p>HP50N SAE-ORB Hollow Hex</p>  <p>F24</p>	<p>HP NPTF Hex Head</p>  <p>F24</p>	<p>SHP NPTF Square Head</p>  <p>F24</p>	<p>HHP NPTF Hollow Hex Head</p>  <p>F24</p>
<p>HPC NPTF Pipe Cap</p>  <p>F25</p>	<p>P87OMN ISO 6149 Hex Head</p>  <p>F25</p>	<p>VSTI M-OR ISO 6149 Hollow Hex</p>  <p>F25</p>	<p>VSTI M-ED Metric-ED Hollow Hex</p>  <p>F25</p>	<p>VSTI R-ED BSPP-ED Hollow Hex</p>  <p>F26</p>	<p>P47OMN BSPP-ORB Hex Head</p>  <p>F26</p>
<p>HP3M BSPT Hex Head</p>  <p>F26</p>					

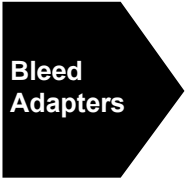
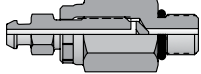
Diagnostic, Orifice and Bleed Adapters (Shown in Section M)

<p>Bleed Adapters</p> 	<p>P50NBA Bleed Screw / Bleed Adapter</p>  <p>M10</p>	<p>HPBA Bleed Screw / NPT</p>  <p>M10</p>
--	---	---



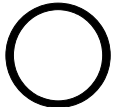
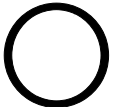
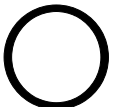
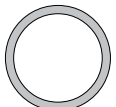
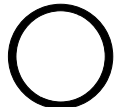
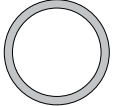









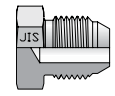
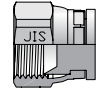

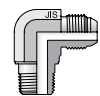

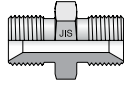
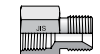
O-Rings and Seals (Shown in Section N)

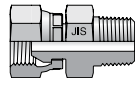
<p>O-Rings and Seals</p> 	<p>SAE O-Ring</p>  <p>N4</p>	<p>ISO 6149 O-Ring</p>  <p>N5</p>	<p>Metric O-Ring</p>  <p>N5</p>	<p>Metric Retaining Ring</p>  <p>N5</p>	<p>BSPP O-Ring</p>  <p>N6</p>
<p>BSPP Retaining Ring</p>  <p>N6</p>					

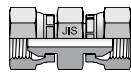

JIS Fittings

H

 <p>30° Flare</p>	<p>F3T4 BSPT / 30° Flare</p>  <p>H5</p>	<p>PNMT4 Plug</p>  <p>H5</p>	<p>FNMT4 Cap</p>  <p>H5</p>	<p>V3T4 BSPT / 30° Flare</p>  <p>H5</p>	<p>C3T4 BSPT / 30° Flare</p>  <p>H5</p>
	<p>F3P4 BSPT / 60° Cone</p>  <p>H5</p>	<p>HP4 Union</p>  <p>H6</p>	<p>G3P4 BSPT / 60° Cone</p>  <p>H6</p>	<p>PNMP4 Plug</p>  <p>H6</p>	<p>F63P4 60° Swivel / BSPT</p>  <p>H6</p>
<p>G63P4 60° Swivel / BSPT</p>  <p>H6</p>	<p>HP46 Union Swivel</p>  <p>H6</p>	<p>FNMP4 Cap</p>  <p>H7</p>	<p>C3P4 BSPT / 60° Cone</p>  <p>H7</p>	<p>V3P4 BSPT / 60° Cone</p>  <p>H7</p>	
<p>B2351 Port</p> 	<p>P47OMN Hex Head Plug</p>  <p>H7</p>				

O-Rings and Seals (Shown in Section N)

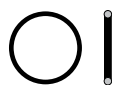







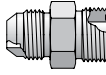
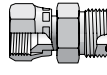
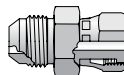
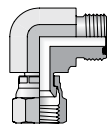

<p>JIS O-Rings and Seals</p> 	<p>JIS B2351 O-Ring</p>  <p>N7</p>
---	--

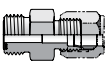
Dimensions and pressures for reference only, subject to change.

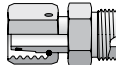

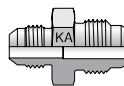
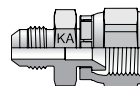
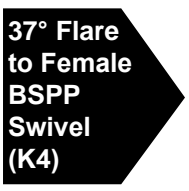
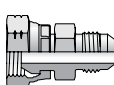
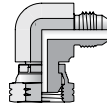

Conversion Adapters

K

	<p>XHLO 37° Flare / ORFS</p>  <p>K3</p>	<p>LOHX6 37° Swivel / ORFS</p>  <p>K3</p>	<p>XHL6 37° Flare / ORFS Swivel</p>  <p>K3</p>	<p>LOEX6 Description</p>  <p>K3</p>	
	<p>BUHLO ORFS / 24° Flareless</p>  <p>K4</p>		<p>LOHU86 Metric 24° Flareless/ORFS</p>  <p>K4</p>		
	<p>XHBU 37° Flare / Flareless</p>  <p>K4</p>	<p>XHBU2 37° / Flareless Bulkhead</p>  <p>K4</p>		<p>XHMKA 37° Flare / 30° Flare</p>  <p>J5</p>	<p>XHMKA6 37° Flare / 30° Swivel</p>  <p>J5</p>
	<p>XHMK46 37° Flare / BSPP Swivel</p>  <p>K5</p>	<p>XEMK46 37° Flare / BSPP Swivel</p>  <p>K5</p>		<p>XHU86 37° / Metric 24° Flareless</p>  <p>K5</p>	

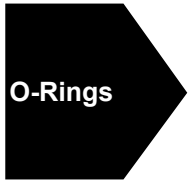







O-Rings and Seals (Shown in Section N)

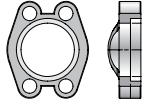
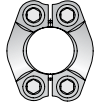

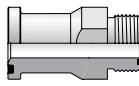
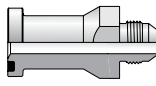
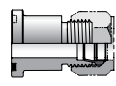
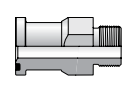
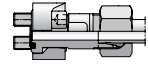
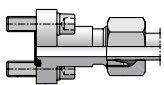
	<p>ORFS O-Ring</p>  <p>N4</p>	<p>EO O-Ring</p>  <p>N10</p>
---	---	--



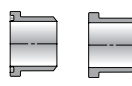
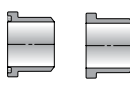
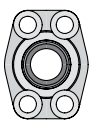
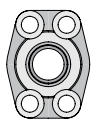
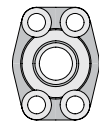
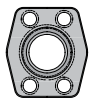
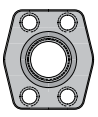
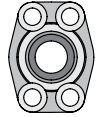
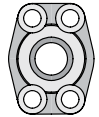
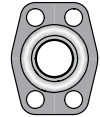
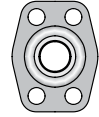
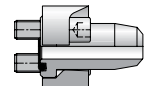
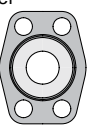
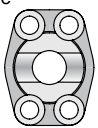
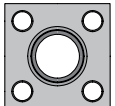
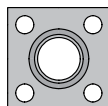
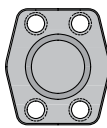
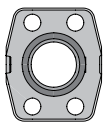
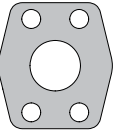
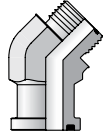
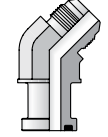
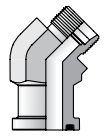
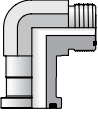
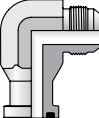
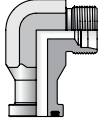
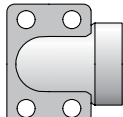
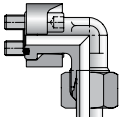

Hydraulic Flanges & Components & Dual Seal Flanges

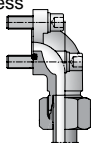
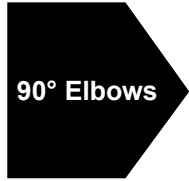
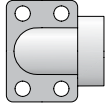
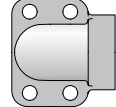
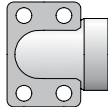
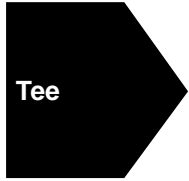
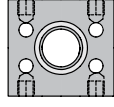
Hydraulic Flanges and Components

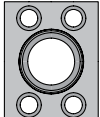
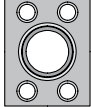
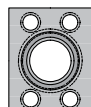
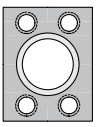





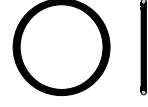



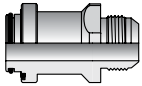

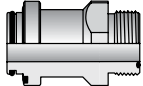
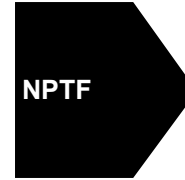
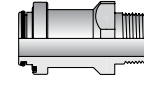
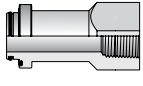
<p>Flange Clamps</p>	<p>FCS Flange Clamps – Split</p>  <p>L9</p>	<p>FCC Flange Clamp – Captive</p>  <p>L9</p>	<p>FHS3 Code 61 Flange Clamps – Metric</p>  <p>L10</p>	<p>FHS6 Code 62 Flange Clamps – Metric</p>  <p>L11</p>	
<p>Straight Flange Adapters / Flanges</p>	<p>LOHQ Code 61, 62 / ORFS</p>  <p>L12</p>	<p>XHQ Code 61, 62 / 37° Flare</p>  <p>L12</p>	<p>BUHQ1 Code 61 / Flareless</p>  <p>L12</p>	<p>F5OHQ Code 61, 62 / SAE-ORB</p>  <p>L13</p>	<p>GFS Code 61, 62 / Metric Flareless</p>  <p>L14</p>
<p>BFG DIN Flange / Metric Flareless</p>  <p>L15</p>	<p>B3HQ Code 61, 62 / Flareless</p>  <p>L13</p>	<p>P Flange Head Plug</p>  <p>L15</p>	<p>W7HQ Flange Head / Pipe Socket</p>  <p>L16</p>	<p>G5HQ Flange Head / SAE-ORB</p>  <p>L16</p>	<p>GHQ Flange Head / NPT</p>  <p>L16</p>
<p>WB1/3/5HQ1 Code 61 / Weld Butt – Pipe</p>  <p>L17</p>	<p>WB3/5/7HQ2 Code 62 / Weld Butt – Pipe</p>  <p>L17</p>	<p>G5Q Code 61, 62 / SAE-ORB</p>  <p>L18</p>	<p>GQ Code 61, 62 / NPT</p>  <p>L18</p>	<p>G4Q Code 61, 62 / BSPP</p>  <p>L19</p>	<p>W5Q Code 61, 62 / Socket – Pipe</p>  <p>L20</p>
<p>W4Q Code 61, 62 / Socket – Tube</p>  <p>L21</p>	<p>W7Q Code 61, 62 / Ext Socket – Pipe</p>  <p>L22</p>	<p>W6Q Code 61, 62 / Ext Socket – Tube</p>  <p>L23</p>	<p>WB1/3/5Q1 Code 61 / Weld Butt – Pipe</p>  <p>L24</p>	<p>WB3/5/7Q2 Code 62 / Weld Butt – Pipe</p>  <p>L25</p>	<p>AS Code 61, 62 / Weld Butt – Tube Metric</p>  <p>L26</p>
<p>WBT Code 61 / Weld Tank Adapter</p>  <p>L26</p>	<p>WSD Code 61, 62 / Weld Saddle</p>  <p>L27</p>	<p>GQS Square Flange / NPT</p>  <p>L27</p>	<p>W5SQS Square Flange / Weld Socket – Pipe</p>  <p>L28</p>	<p>PQ Code 61, 62 / Blank</p>  <p>L28</p>	<p>SPGG5 Flange Spacer w/Gage Ports</p>  <p>L29</p>
<p>CP Flange Connector Plate</p>  <p>L29</p>	<p>45° Flange Adapters</p>	<p>LOVQ Code 61, 62 / ORFS</p>  <p>L30</p>	<p>XVQ Code 61, 62 / 37° Flare</p>  <p>L30</p>	<p>BUVQ1 Code 61 / Flareless</p>  <p>L30</p>	
<p>90° Flange Adapters</p>	<p>LOEQ Code 61, 62 / ORFS</p>  <p>L31</p>	<p>XEQ Code 61, 62 / 37° Flare</p>  <p>L31</p>	<p>BUEQ1 Code 61 / Flareless</p>  <p>L31</p>	<p>W7EQ Code 61, 62 / Weld Socket – Pipe</p>  <p>L32</p>	<p>WFS Code 61, 62 / Metric Flareless</p>  <p>L33</p>

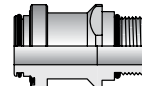
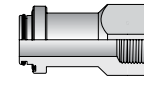
<p>BFW DIN Flange / Metric Flareless</p>  <p>L34</p>	<p>90° Elbows</p> 	<p>G5EQ Code 61, 62 / SAE-ORB</p>  <p>L35</p>	<p>GEQ Code 61, 62 / NPT</p>  <p>L36</p>	<p>W6EQ Code 61, 62 / Weld Socket – Tube</p>  <p>L37</p>	
<p>Tee</p> 	<p>QPQPJQ Code 61, 62 Junction Tee</p>  <p>L35</p>	<p>Stainless Steel Flanges</p> 	<p>G5Q Code 61, 62 / SAE-ORB</p>  <p>L38</p>	<p>GQ Code 61, 62 / NPT</p>  <p>L38</p>	<p>W5Q Code 61, 62 / Weld Socket – Pipe</p>  <p>L39</p>
<p>PQ Code 61, 62 / Blank</p>  <p>L40</p>					

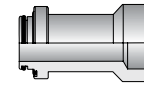
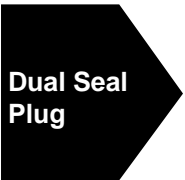
O-Rings and Seals (Shown in Section N)

<p>O-Rings and Seals</p> 	<p>ORFS O-Ring</p>  <p>N4</p>	<p>SAE 4-Bolt Flange O-Ring</p>  <p>N10</p>
--	---	---

Dual Seal Flanges

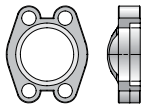
 <p>37° Flare</p>	<p>XHQ40 37° Flare</p>  <p>L41</p>	 <p>ORFS</p>	<p>LOHQ40 ORFS</p>  <p>L41</p>	 <p>NPTF</p>	<p>FHQ40 Male NPTF</p>  <p>L41</p>
<p>GHQ40 Female NPTF</p>  <p>L42</p>	 <p>SAE-ORB</p>	<p>F5OHQ40 Male SAE-ORB</p>  <p>L42</p>	<p>G5HQ40 Female SAE-ORB</p>  <p>L42</p>	 <p>Socket Weld Pipe</p>	<p>W7HQ40 Socket Weld Pipe</p>  <p>L43</p>
 <p>Dual Seal Plug</p>	<p>PQ40 Dual Seal Plug</p>  <p>L43</p>	 <p>Q4 Insert</p>	<p>Q4 Insert Flange Insert</p>  <p>L43</p>		
 <p>Flange Clamps</p>	<p>FCS Flange Clamps – Split</p>  <p>L9</p>	<p>FCC Flange Clamp – Captive</p>  <p>L9</p>			

O-Rings and Seals (Shown in Section N)

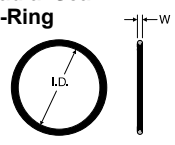
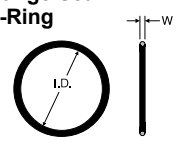
 <p>O-Rings and Seals</p>	<p>Radial Seal O-Ring</p>  <p>N10</p>	<p>Flange Seal O-Ring</p>  <p>N10</p>
---	---	---